



AO8802

Common-Drain Dual N-Channel Enhancement Mode Field Effect Transistor

General Description

The AO8802 uses advanced trench technology to provide excellent $R_{DS(ON)}$, low gate charge and operation with gate voltages as low as 1.8V while retaining a 12V $V_{GS(MAX)}$ rating. This device is suitable for use as a uni-directional or bi-directional load switch, facilitated by its common-drain configuration.

Features

- V_{DS} (V) = 20V
- I_D = 8A
- $R_{DS(ON)} < 13m\Omega$ ($V_{GS} = 10V$)
- $R_{DS(ON)} < 14m\Omega$ ($V_{GS} = 4.5V$)
- $R_{DS(ON)} < 19m\Omega$ ($V_{GS} = 2.5V$)
- $R_{DS(ON)} < 27m\Omega$ ($V_{GS} = 1.8V$)

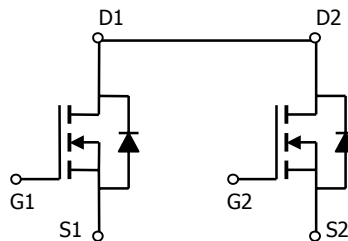
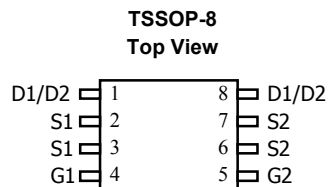

Absolute Maximum Ratings $T_A=25^\circ C$ unless otherwise noted

Parameter	Symbol	Maximum	Units
Drain-Source Voltage	V_{DS}	20	V
Gate-Source Voltage	V_{GS}	± 12	V
Continuous Drain Current ^A	$T_A=25^\circ C$	8	A
	$T_A=70^\circ C$	6.3	
Pulsed Drain Current ^B	I_{DM}	30	
Power Dissipation ^A	$T_A=25^\circ C$	1.5	W
	$T_A=70^\circ C$	1.08	
Junction and Storage Temperature Range	T_J, T_{STG}	-55 to 150	$^\circ C$

Thermal Characteristics

Parameter	Symbol	Typ	Max	Units
Maximum Junction-to-Ambient ^A	$R_{\theta JA}$	64	83	$^\circ C/W$
Maximum Junction-to-Ambient ^A		Steady-State	89	
Maximum Junction-to-Lead ^C	$R_{\theta JL}$	53	70	$^\circ C/W$

Electrical Characteristics ($T_J=25^\circ\text{C}$ unless otherwise noted)

Symbol	Parameter	Conditions	Min	Typ	Max	Units
STATIC PARAMETERS						
BV_{DSS}	Drain-Source Breakdown Voltage	$I_D=250\mu\text{A}$, $V_{GS}=0\text{V}$	20			V
I_{DSS}	Zero Gate Voltage Drain Current	$V_{DS}=16\text{V}$, $V_{GS}=0\text{V}$ $T_J=55^\circ\text{C}$			10 25	μA
I_{GSS}	Gate-Body leakage current	$V_{DS}=0\text{V}$, $V_{GS}=\pm 12\text{V}$			100	nA
$V_{GS(th)}$	Gate Threshold Voltage	$V_{DS}=V_{GS}$, $I_D=250\mu\text{A}$	0.5	0.75	1	V
$I_{D(ON)}$	On state drain current	$V_{GS}=4.5\text{V}$, $V_{DS}=5\text{V}$	30			A
$R_{DS(ON)}$	Static Drain-Source On-Resistance	$V_{GS}=10\text{V}$, $I_D=8\text{A}$ $T_J=125^\circ\text{C}$		10 13.3	13 16	$\text{m}\Omega$
		$V_{GS}=4.5\text{V}$, $I_D=5\text{A}$		11.5	14	$\text{m}\Omega$
		$V_{GS}=2.5\text{V}$, $I_D=4\text{A}$		15.4	19	$\text{m}\Omega$
		$V_{GS}=1.8\text{V}$, $I_D=3\text{A}$		22.2	27	$\text{m}\Omega$
g_{FS}	Forward Transconductance	$V_{DS}=5\text{V}$, $I_D=8\text{A}$		36		S
V_{SD}	Diode Forward Voltage	$I_S=1\text{A}$, $V_{GS}=0\text{V}$		0.73	1	V
I_S	Maximum Body-Diode Continuous Current				2.4	A
DYNAMIC PARAMETERS						
C_{iss}	Input Capacitance	$V_{GS}=0\text{V}$, $V_{DS}=10\text{V}$, $f=1\text{MHz}$		1810		pF
C_{oss}	Output Capacitance			232		pF
C_{rss}	Reverse Transfer Capacitance			200		pF
R_g	Gate resistance	$V_{GS}=0\text{V}$, $V_{DS}=0\text{V}$, $f=1\text{MHz}$		1.6		Ω
SWITCHING PARAMETERS						
Q_g	Total Gate Charge	$V_{GS}=4.5\text{V}$, $V_{DS}=10\text{V}$, $I_D=8\text{A}$		19.8		nC
Q_{gs}	Gate Source Charge			1.8		nC
Q_{gd}	Gate Drain Charge			5		nC
$t_{D(on)}$	Turn-On DelayTime	$V_{GS}=10\text{V}$, $V_{DS}=10\text{V}$, $R_L=1.3\Omega$, $R_{GEN}=3\Omega$		3.3		ns
t_r	Turn-On Rise Time			5.9		ns
$t_{D(off)}$	Turn-Off DelayTime			44		ns
t_f	Turn-Off Fall Time			7.7		ns
t_{rr}	Body Diode Reverse Recovery Time	$I_F=8\text{A}$, $dI/dt=100\text{A}/\mu\text{s}$		22		ns
Q_{rr}	Body Diode Reverse Recovery Charge	$I_F=8\text{A}$, $dI/dt=100\text{A}/\mu\text{s}$		9.8		nC

A: The value of $R_{\theta JA}$ is measured with the device mounted on 1in² FR-4 board with 2oz. Copper, in a still air environment with $T_A=25^\circ\text{C}$. The value in any a given application depends on the user's specific board design. The current rating is based on the $t \leq 10\text{s}$ thermal resistance rating.

B: Repetitive rating, pulse width limited by junction temperature.

C. The $R_{\theta JA}$ is the sum of the thermal impedance from junction to lead $R_{\theta JL}$ and lead to ambient.

D. The static characteristics in Figures 1 to 6,12,14 are obtained using 80 μs pulses, duty cycle 0.5% max.

E. These tests are performed with the device mounted on 1 in² FR-4 board with 2oz. Copper, in a still air environment with $T_A=25^\circ\text{C}$. The SOA curve provides a single pulse rating.

TYPICAL ELECTRICAL AND THERMAL CHARACTERISTICS

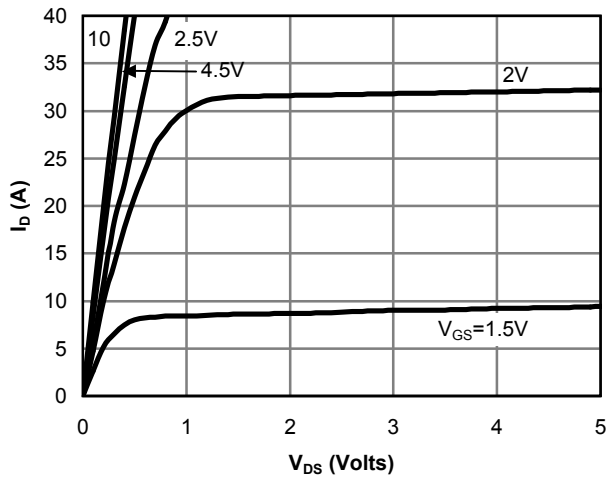

Fig 1: On-Region Characteristics

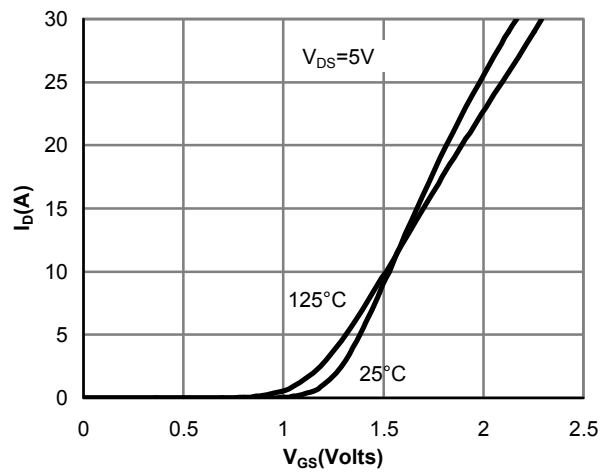

Figure 2: Transfer Characteristics

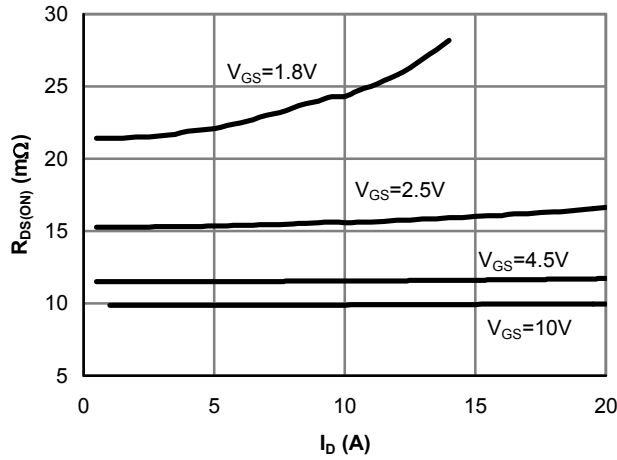

Figure 3: On-Resistance vs. Drain Current and Gate Voltage

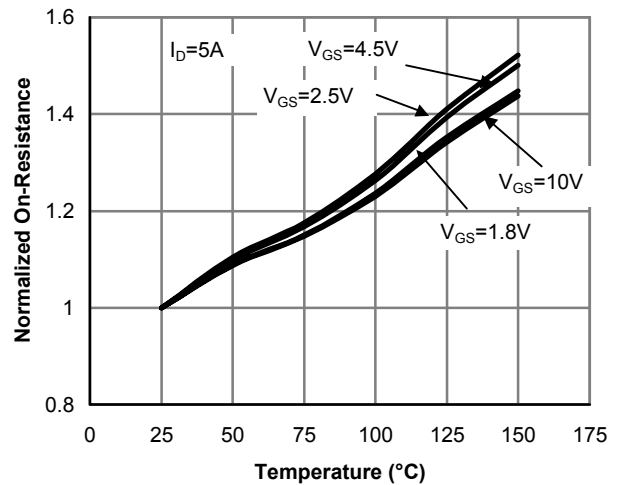

Figure 4: On-Resistance vs. Junction Temperature

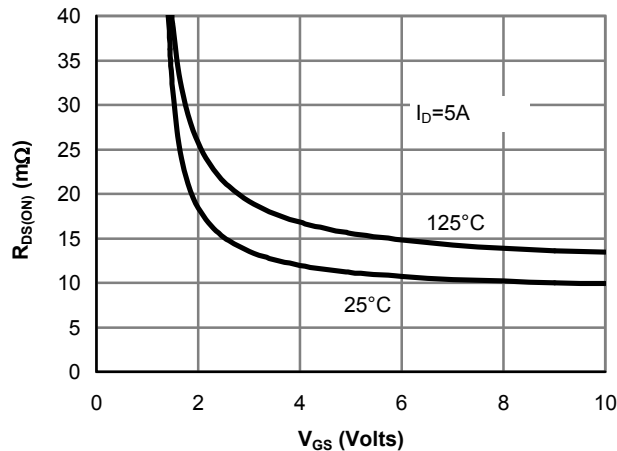

Figure 5: On-Resistance vs. Gate-Source Voltage

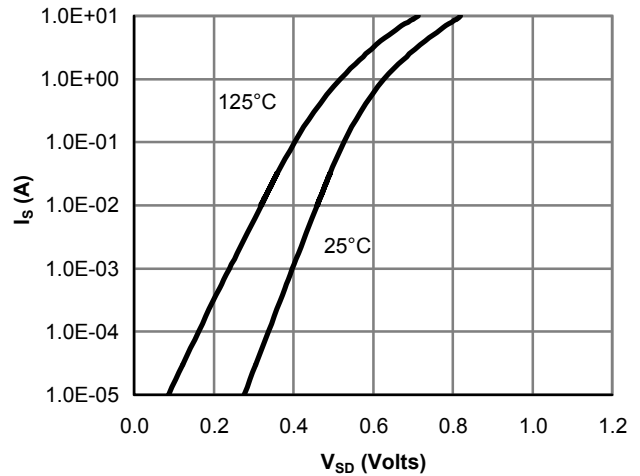

Figure 6: Body-Diode Characteristics

TYPICAL ELECTRICAL AND THERMAL CHARACTERISTICS

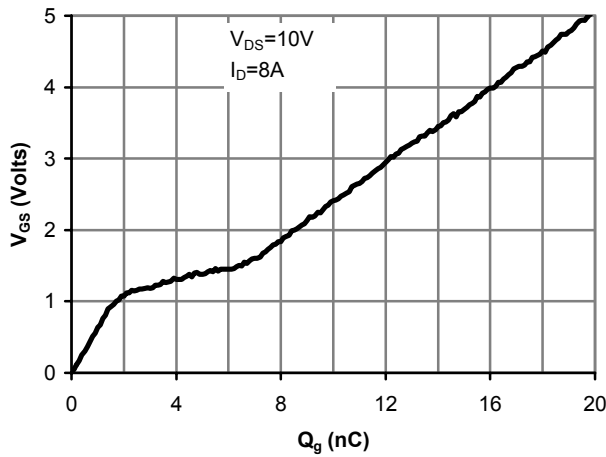

Figure 7: Gate-Charge Characteristics

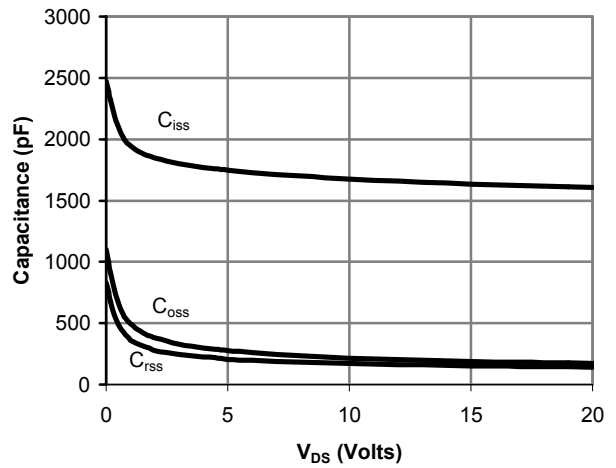

Figure 8: Capacitance Characteristics

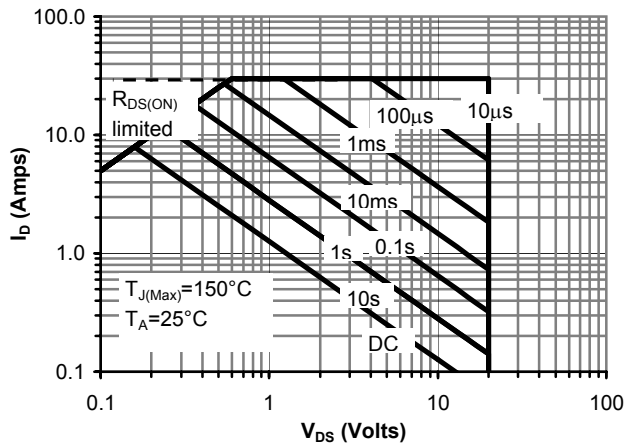

Figure 9: Maximum Forward Biased Safe Operating Area (Note E)

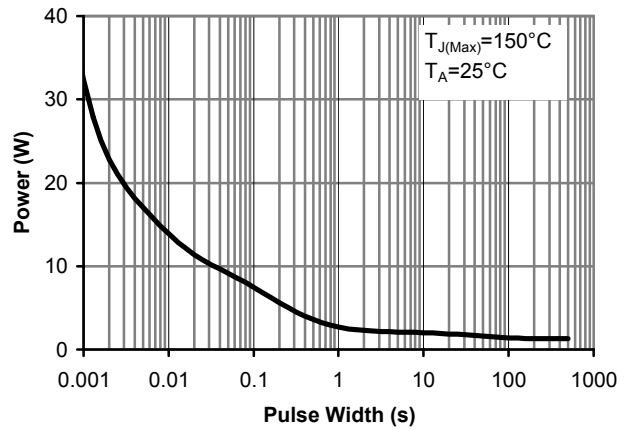

Figure 10: Single Pulse Power Rating Junction-to-Ambient (Note E)

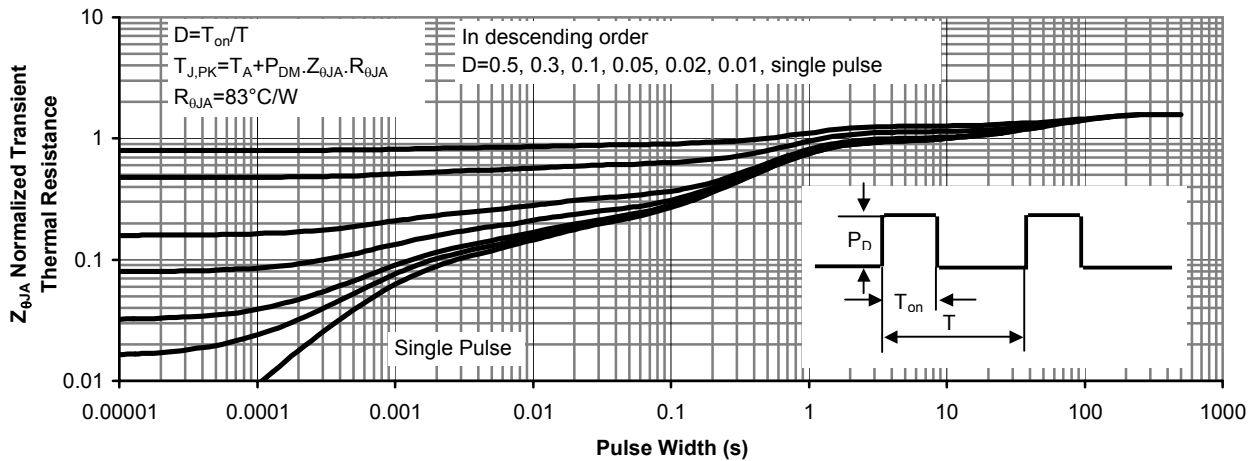
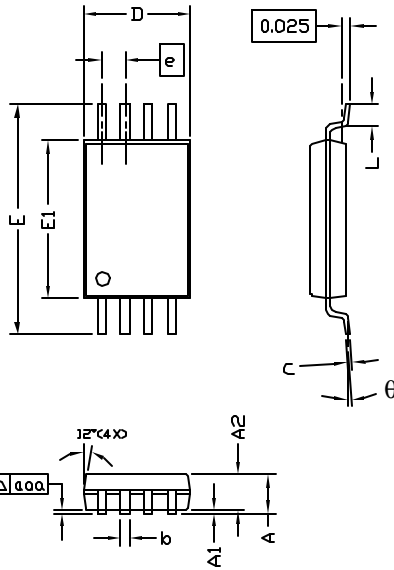

Figure 11: Normalized Maximum Transient Thermal Impedance



SYMBOLS	DIMENSIONS IN MILLIMETERS			DIMENSIONS IN INCHES		
	MIN	NOM	MAX	MIN	NOM	MAX
A	—	—	1.20	—	—	0.047
A1	0.05	—	0.15	0.002	—	0.006
A2	0.80	1.00	1.05	0.031	0.039	0.041
b	0.19	—	0.30	0.007	—	0.012
c	0.09	—	0.20	0.004	—	0.008
D	2.90	3.00	3.10	0.114	0.118	0.122
E	6.40 BSC			0.252 BSC		
E1	4.30	4.40	4.50	0.169	0.173	0.177
e	0.65 BSC			0.0259 (REF)		
L	0.45	0.60	0.75	0.018	0.024	0.030
y	—	—	0.10	—	—	0.004
θ	0°	—	8°	0°	—	8°

- NOTE:
- LEAD FINISH: 150 MICRONS (3.8 um) MIN. THICKNESS OF Tin/Lead (SOLDER) PLATED ON LEAD
 - TOLERANCE ±0.10 mm (4 mil) UNLESS OTHERWISE SPECIFIED
 - COPLANARITY : 0.10 mm
 - DIMENSION L IS MEASURED IN GAGE PLANE

PACKAGE MARKING DESCRIPTION



- NOTE:
- LOGO - AOS LOGO
 - 8802 - PART NUMBER CODE.
 - F - FAB LOCATION
 - A - ASSEMBLY LOCATION
 - W - WEEK CODE.
 - L N - ASSEMBLY LOT CODE

RECOMMENDED LAND PATTERN

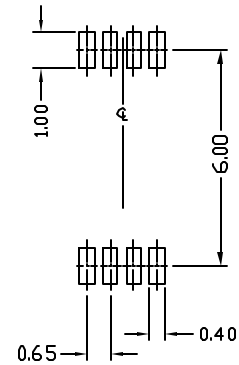

UNIT: mm

TSSOP-8 PART NO. CODE

PART NO.	CODE	PART NO.	CODE	PART NO.	CODE
AO8802	8802				



ALPHA & OMEGA
SEMICONDUCTOR, INC.

TSSOP-8 Tape and Reel Data

TSSOP-8 Carrier Tape

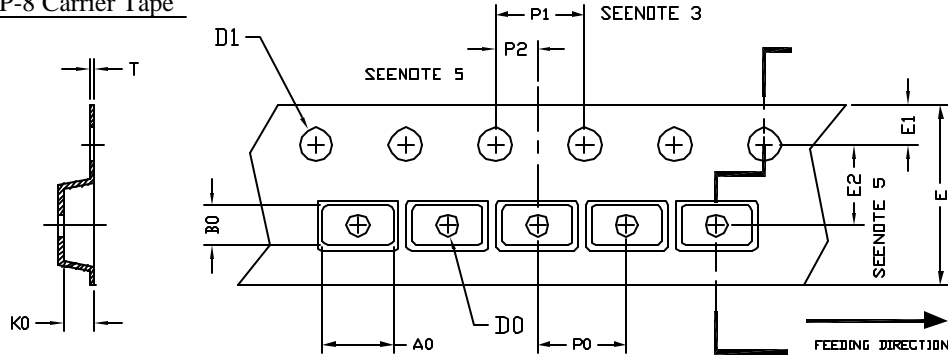

UNIT: MM

PACKAGE	A0	B0	K0	D0	D1	E	E1	E2	P0	P1	P2	T
SD-8 (12 mm)	6.80 ±0.10	3.40 ±0.10	1.60 ±0.10	1.50 ±0.10	1.30 MIN.	12.00 ±0.30	1.75 ±0.10	5.50 ±0.05	8.00 ±0.10	4.00 ±0.10	2.00 ±0.10	0.30 ±0.05

TSSOP-8 Reel

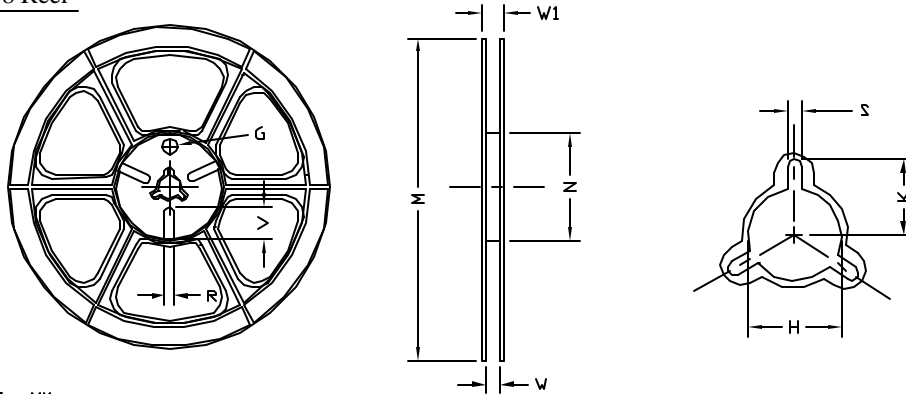

UNIT: MM

TAPE SIZE	REEL SIZE	M	N	W	W1	H	K	S	G	R	V
12 mm	φ330	φ178.00 ±0.50	φ60.00 ±0.50	13.00 +1.50 -0.00	16.00 ±1.00	φ13.50 ±0.50	10.60	2.20 ±0.50	---	---	---

TSSOP-8 Tape

Leader / Trailer
& Orientation

